

### **Modelling and Simulating Hybrid Electrical Vehicle for Toyota Soluna with Parallel Drive Train Configuration**

Danny Setiawan<sup>1</sup>, Mohammad Yamin<sup>2</sup>  
Faculty of Industry Technology, Gunadarma University<sup>1,2)</sup>  
mesin.harajuku@gmail.com<sup>1,2)</sup>

#### **ABSTRACT**

*This simulation was using the parallel configuration in Simulink modeling (MATLAB software) to be obtained engine and vehicle performance result. The base vehicle using Toyota Soluna with added parallel drive train configuration with electric motor in rear side, the simulation purpose for determined an efficiency using electric motor with a model brushless DC motor maximum power 11 kW. Another purpose was knowing maximum velocity for Toyota Soluna using ICE engine with added a battery and electrical component using simulation, this simulating would be run after connecting subsystems inside program, the subsystem resembled a engine function, electrical component, transmission and mechanical component.*

**Keyword:** *Effeciency, Simulink, Torque, Speed, Power, Energy Recycle.*

#### **INTRODUCTION**

Many large corporations, universities and others Research Company used a program as their asset to analysis and modeling a project, this project might be expected to require great material before research the real thing

So then for simulated the huge project like vehicle modeling, it's required something a mathematics equation with calculating program inside, the program like MATLAB Simulink was the program used by many researcher for calculating complicated mathematics relation, because this program have many mathematics equation template and using for valid data with mathematical methods and matrices.

#### **RESEARCH METHODE**

The HEV components are divided into two general components, they are mechanical components based on combustion motor and electronic components based on the electrical motor. The mechanical components consisting of ICE, transmission, and the vehicle body whom consisting of the weight of vehicle, and the electronic component consisting of a electric motor, electric generator, batteries, and battery control systems.

In the gear transmission system there are two gears, each interconnected with the electrical components and vehicle body components. The transmission for ICE was using the normal transmission from Toyota engine (it wasn't changing into planetary gear like Toyota Prius), so then driving force transmission has a normal gear ratio.

For electrical transmission system was using a some simple gear connected directly with driving force (differential gear) on the rear, so then it can to be charge and discharge electric energy. The performance of the transmission shaft rotation speed and the power generated by motor was calculating using the basic formula of the calculation of the transmission speed<sup>[1][2][3]</sup>:

$$\omega = \frac{H}{\tau}$$

Where  $\omega$  is the rotational speed, H is the power transmission and  $\tau$  is the torque transmission. Then the power and torque values obtained are as follows <sup>[4][5][6]</sup>:

$$H = \frac{F \cdot v}{33000} = \frac{2\pi \cdot \tau \cdot n}{33000(12)}$$

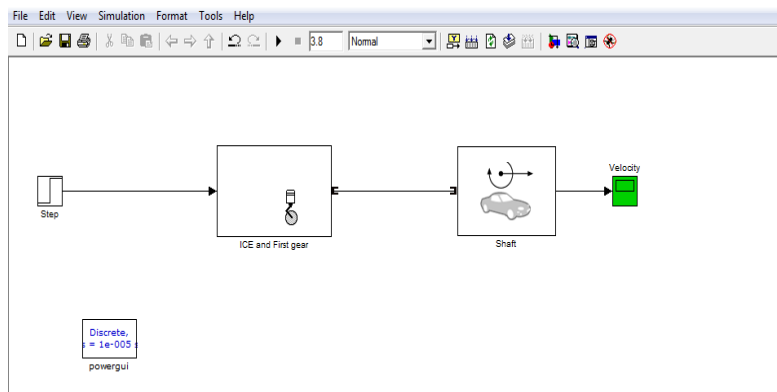
Where the driving force (rear) was from vehicle move, and velocity from the engine. The torque produced was from the rotational force multiple with the tire radius (front). And n was resemble for rpm (speed).

Using a table 2.1, the configuration was using modification of Simulink block program with value inside the table 2.1. So then modeling HEV of Toyota Soluna can be shown in figure 2.1 and 2.2, where this figure was determined a ICE subsystem and electrical motor subsystem in Simulink.

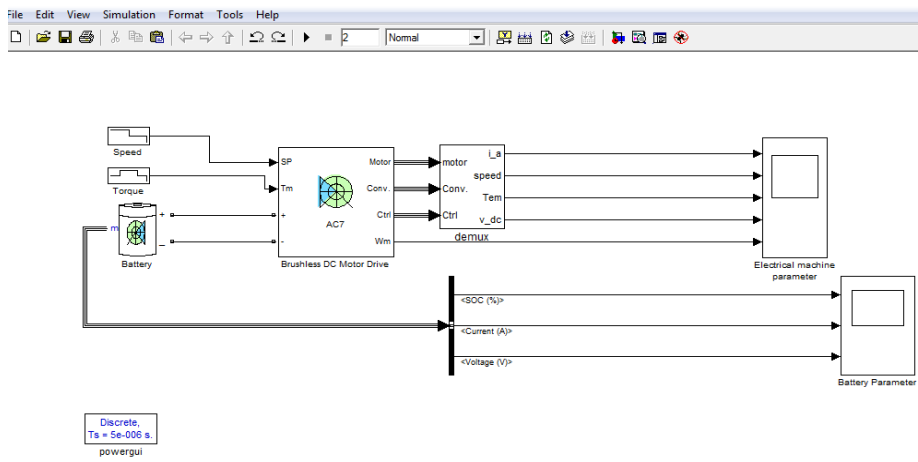
Another figure like figure 2.3 and 2.4, describe the transmission modeling and electrical motor modeling with the value from table 2.1.

**Table 1. Combustion Engine Specification**

Specification	Value
Output	78000 W
Torque	131 Nm
Rotation (max)	6000 rpm
Maximum Velocity	120 km/h
Shaft Radius	21.5 mm
Maximum Force	6078 N

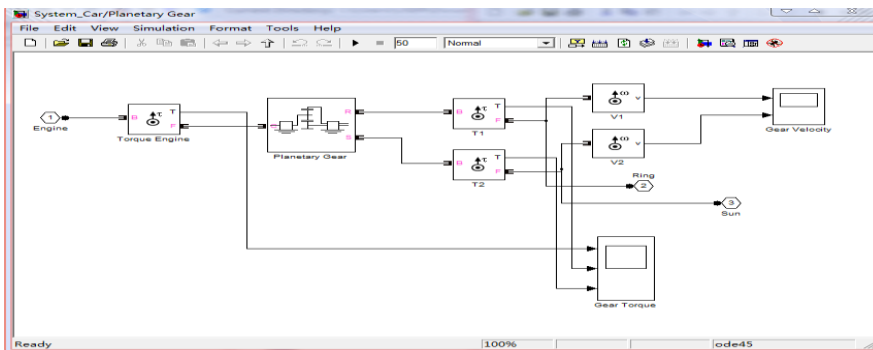


**Figure 1. Mechanical component subsystem**

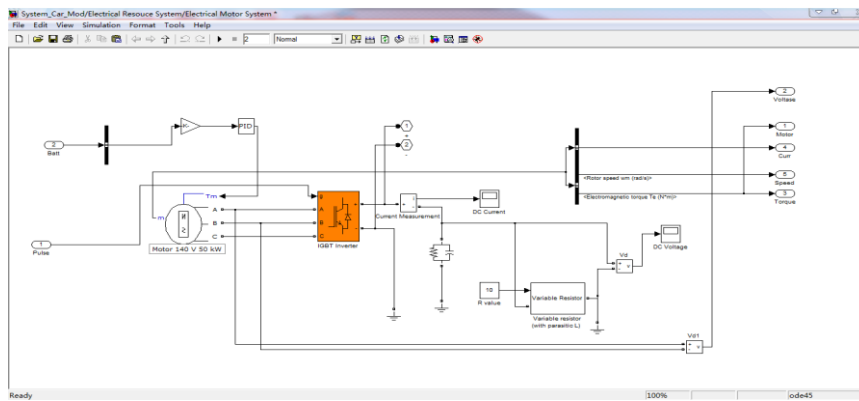


**Figure 2. Electric component block model**

Based on the above picture described above, the modeling was built in MATLAB Simulink. The block using a Simulink template, including step control, gasoline engine and transmission subsystems and car subsystem.



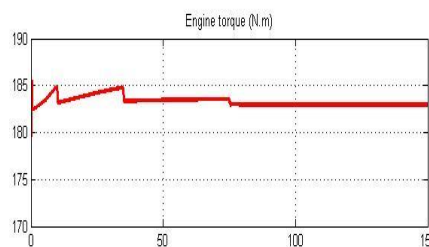
**Figure 3. Transmission modeling [7].**



**Figure 4. Electrical motor modeling [7].**

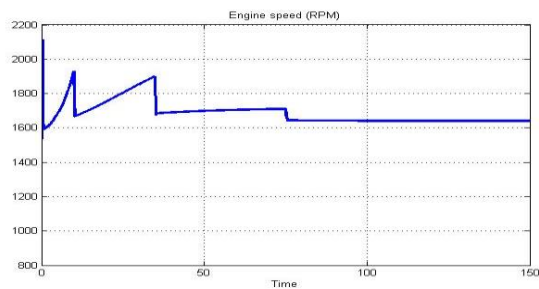
## ANALYSIS AND CONCLUSION

The analysis was resemble for engine performance like torque, speed, power, and velocity, but for electrical component was add the electric performance like voltage, current and regenerated electric battery power. The torque simulation using a normal transmission gear ratio as follows on figure 3.1:



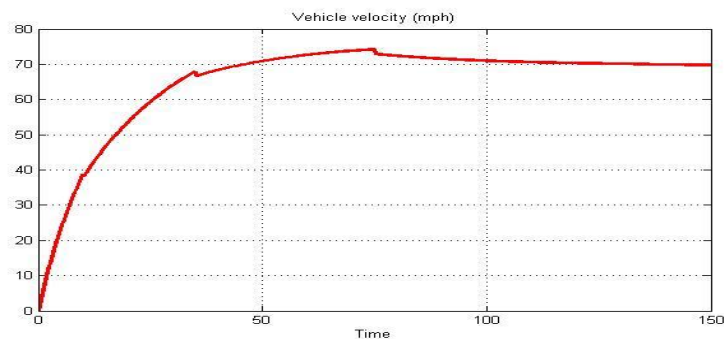
**Figure 5. ICE Torque.**

The torque from above was using the 4 speed gear ratio, so the maximum torque was in the first and second gear. The another performance produce by ICE is the speed. Speed result from the modeling is:

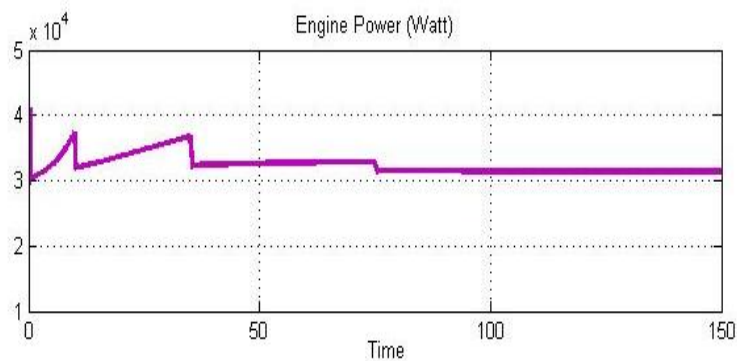


**Figure 6. ICE Speed**

The speed on above actually same line like torque, because the speed was affected the torque performance (in mechanical design), so then the speed result line as same as the torque result line. After that, the another engine performance like velocity and power can reach using the modeling simulation is:



**Figure 7. Vehicle velocity in simulation**



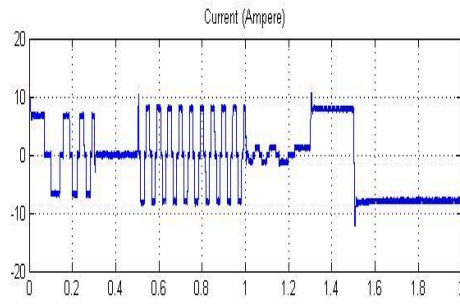
**Figure 8. Vehicle Power engine performance in simulation**

Based on the value generated by MATLAB which is the average torque on transmission is 121 Nm, with average rotation speed is 2160 rpm, the power generated average is <sup>[4][6]</sup>:

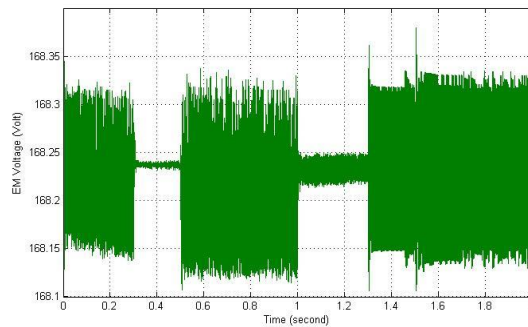
$$P_{Ra} = \tau_{Ra} \cdot \omega_{Ra}$$

$$P_{Ra} = 120 \times 2160 = 25,92 \text{ kW}$$

Then the following is a calculation of the value of current and voltage on the electric motor that work in HEV is:



**Figure 9. Current motor.**



**Figure 10. Voltage motor.**

Based on the picture above the average voltage is 168 V with a maximum current value is 10.2 A. Based on the energy required to drive the motor is <sup>[3]</sup>:

$$E = 168 \text{ V} \times 10,2 \text{ A} = 1713,6 \text{ Ws}$$

So based on the energy taken from the battery voltage 144 V with an electric current of 7.5 A. Comparison of the required energy taken from the battery to drive a motor is <sup>[3][4][6]</sup>:

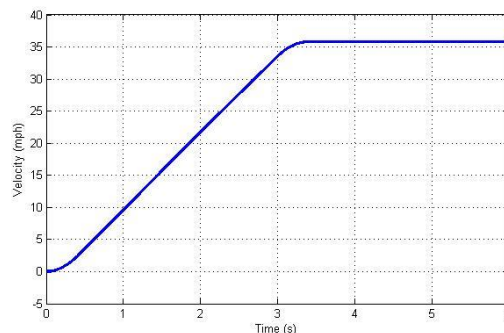
$$\frac{E_{mot}}{E_{batt}} = \frac{1713,6 \text{ Ws}}{144 \text{ V} \times 7,5 \text{ A}} = 1,587$$

So if a motor needs to spin energy, the energy that must be removed by 1.587 times the amount of energy released from the battery. In addition to the time required to achieve maximum power is <sup>[6]</sup>:

$$t = \frac{P}{E_{mot}} = \frac{1080 \text{ Wh}}{1713,6 \text{ W}} = 0,63 \text{ hour}$$

The time was resemble for state of discharge the 7.5 A was 0.63 hour for average speed (that is equally to 4.41 hour for 100% discharge).

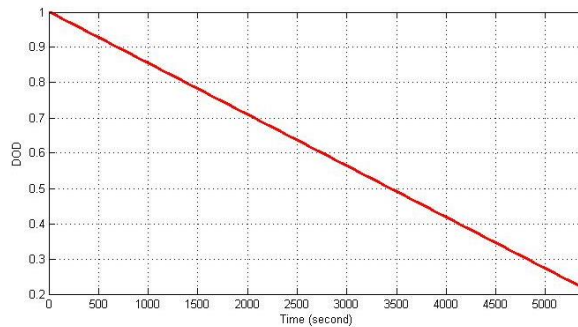
The velocity result using the EM is:



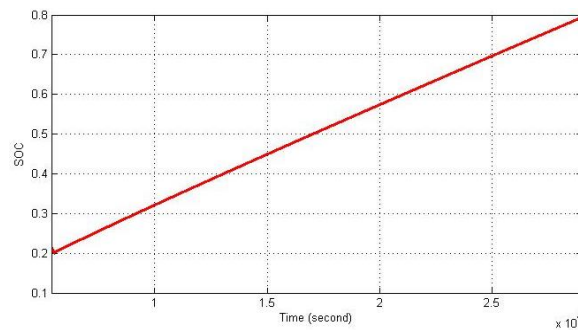
**Figure 11. Vehicle velocity using EM**

The average velocity using EM was 35 km/h, that is more smaller than the motor output specification where can produce almost 50 km/h, maybe the simulation wasn't good for using the Simulink template.

For % State Of Charge (SOC) and % Depth Of Discharge (DOD) battery the result is:



**Figure 12. Percentage Depth of discharge LiFePO4 battery**



**Figure 13. Percentage State of charge LiFePO4 battery**

From above the battery is have much time for generated than the degenerated, maybe the problem is the electrical motor specification wasn't good for generator, only better for motor power only.

For calculating the life of battery using formula and simulation wasn't same, the time from formula was 4.41 hour for battery is dead, and from simulation was 2 hour for battery is dead, i think this only the different calculation formula between basic formula and advance formula in Simulink.

**Table 2. Conclusion of Data Transmission Research on Modelling**

Name	Value
ICE Average Speed	2160 rpm
ICE Average Torque	121 Nm
ICE Average Power	25.92 kW
Voltage Motor	168 V
Current Motor	10,2 A
Maximum Motor Energy	1713,6 J
Maximum Velocity (using ICE)	127.2 km/h
Maximum Velocity (using EM)	35.5 km/h

## Discussion

From the simulation result, the error performance using the basic formula and Simulation formula was high (only for charging, discharge battery and velocity using EM), the error can reach to >50% for state of battery and velocity, the problem was formula used was more complicated than the basic formula, and this study can knowing after analysis with using a real object.

## REFERENCE

- [1] Mi, C., & Masrur, M. A. (2017). Hybrid electric vehicles: principles and applications with practical perspectives. John Wiley & Sons.
- [2] Goswami, D. Yogi, and Frank Keith, 2008, *Energy Conversion*, CRC Press, U.S.A.
- [3] Budynas, and Nisbett, 2008, *Shigley's Mechanical and Engineering Design*, eighth edition, U.S.A.
- [4] Fuhs, A. 2008. Hybrid Vehicles: And The Future Of Personal Transportation. CRC press.
- [5] Kaloko, B. S., Soebagio, M. H. P., & Purnomo, M. H. (2011). Design and development of small electric vehicle using MATLAB/Simulink. *International Journal of Computer Applications*, 24(6), 19-23.
- [6] Jazar, Reza. N, 2008, *Vehicle Dynamics: Theory and Applications*, Springer, Europe.
- [7] Setiawan, Danny, 2012, *Modeling Hybrid Electrical Vehicle using MATLAB and Simulink*. Gunadarma Journal, Jakarta
- [8] Guerra, Alejandra de la; Luis Alvarez and Lizeth Torrezs, 2018, *Brushless DC Motor Control with Unknown Torque Load*, IFAC Paper line 51-53, Elsevier, Mexico
- [9] Yin, Yulong; Xiofeng Yin; Wei Luo and Hua Sun, 2017, *Comparison of Electric Vehicles Equipments with Fixed Ratio Gearbox and Two-Speed Gearbox*, IJMECH Journal Vol 6, No2, China.
- [10] Baruach, Ankur; Tanuja Sheorey and Vijay Kumar Gupta, *Model Based Design of Parallel HEV*, IJRSI Journal Vol 3 pp 59-65, India
- [11] Enang, W., Bannister, C., Brace, C., & Vagg, C. 2015. Modelling and heuristic control of a parallel hybrid electric vehicle. *Proceedings of the Institution of Mechanical Engineers, Part D: Journal of Automobile Engineering*, 229(11), 1494-1513.